

PF 1 KM 0.0093
BETONOVÝ MOST KM 0.0057

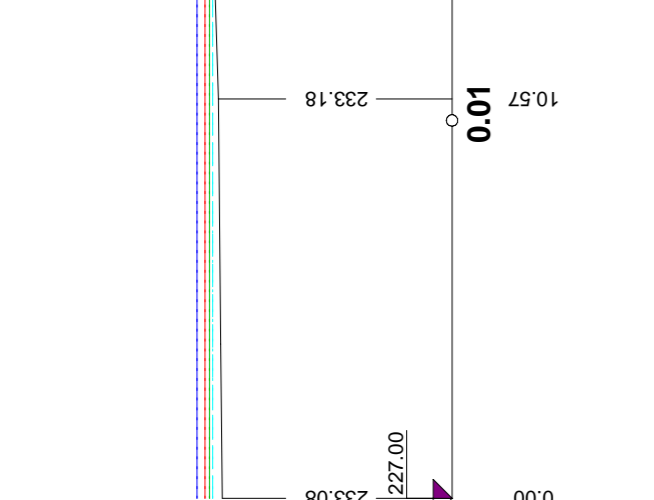

PF 2 KM 0.0142

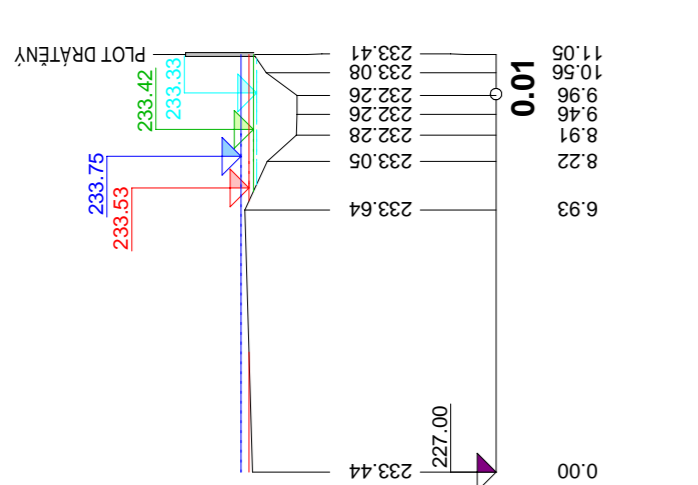

PF 3 KM 0.0477
DŘEVĚNÁ LAVKA KM 0.0472

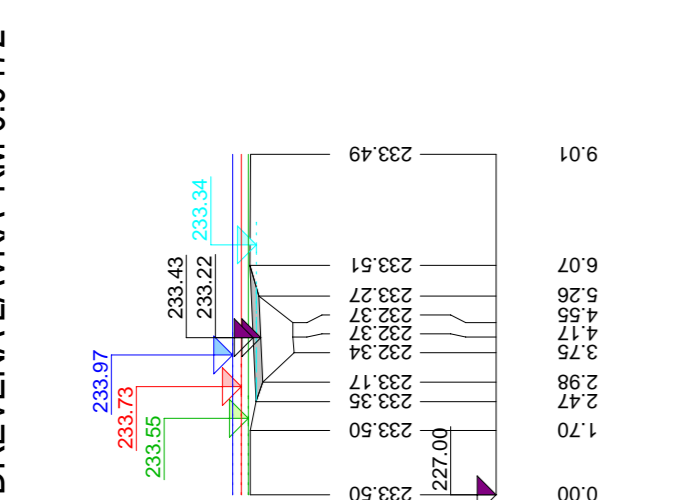

PF 4 KM 0.0704
DŘEVĚNÁ LAVKA KM 0.0696

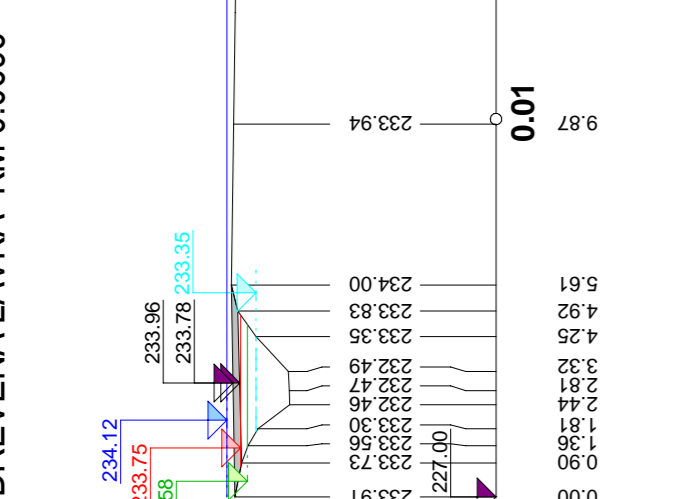

PF 5 KM 0.1195
DŘEVĚNÁ LAVKA KM 0.1190

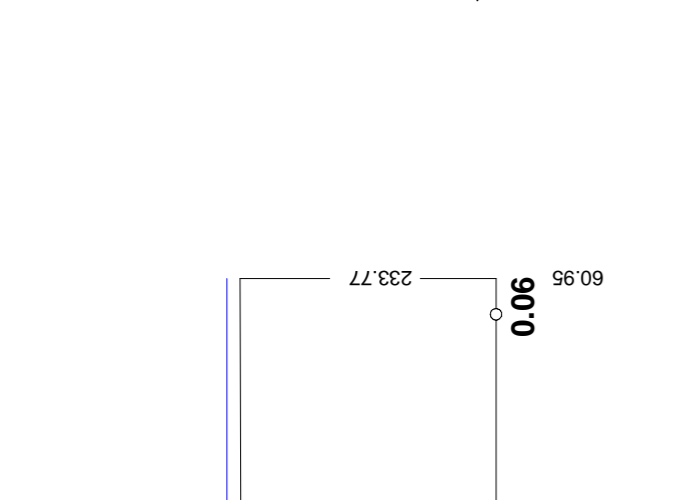

PF 6 KM 0.1761
LAVKA KM 0.1751

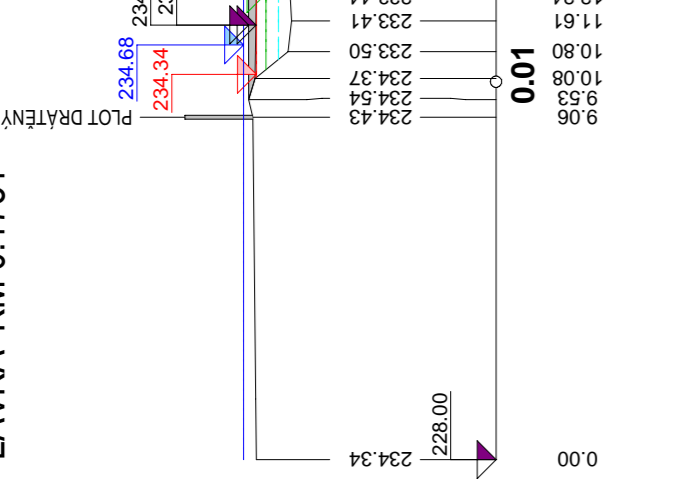

PF 7 KM 0.2446

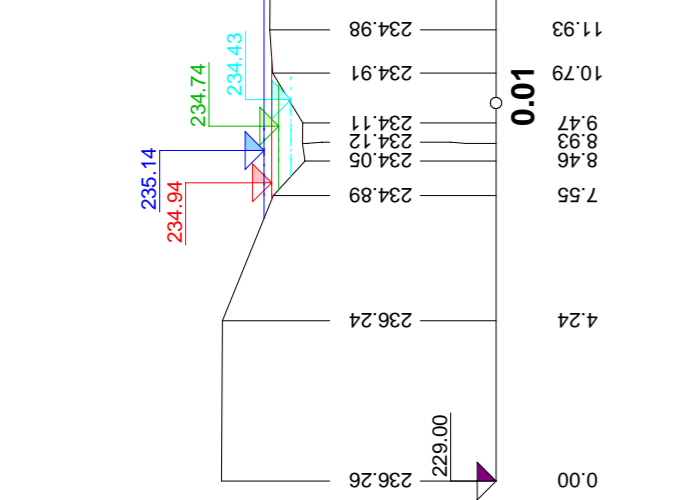

PF 8 KM 0.2828
SILNIČNÍ MOST KM 0.2783

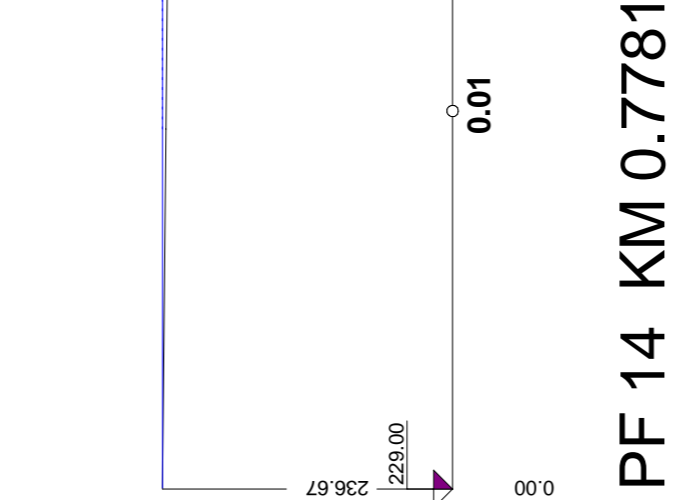

PF 9 KM 0.3513
BETONOVÁ LAVKA KM 0.3507

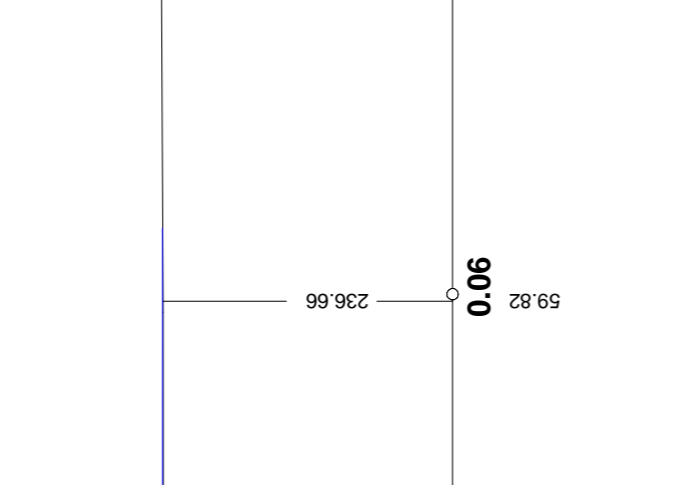

PF 10 KM 0.4104
KLENBOVÝ SILNIČNÍ MOST KM 0.4064

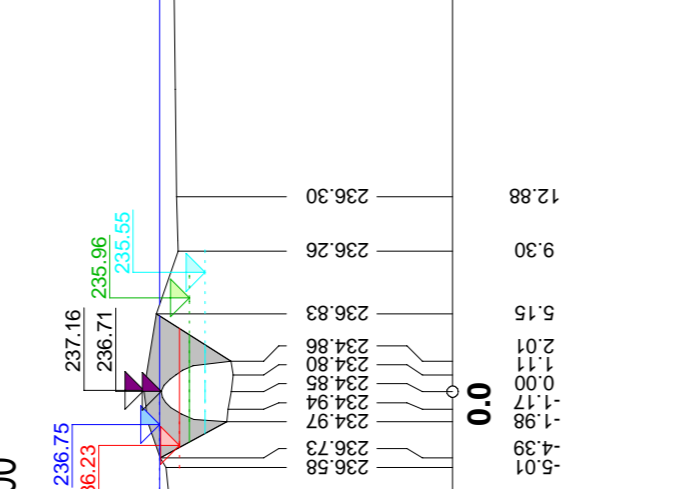

PF 11 KM 0.5351
M 500/200

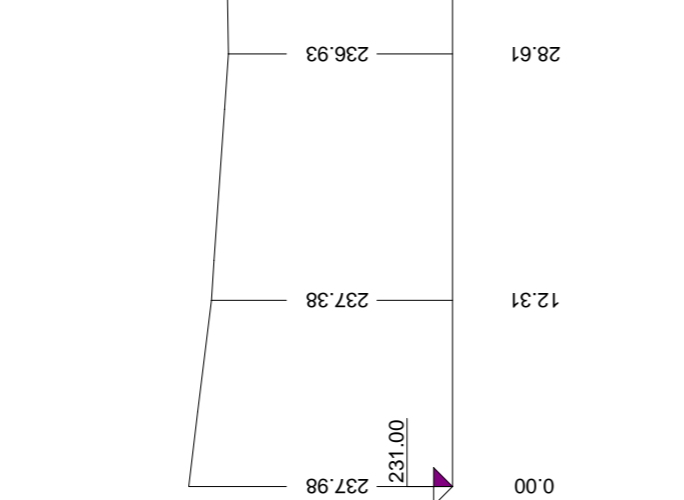

PF 12 KM 0.6254
M 500/200

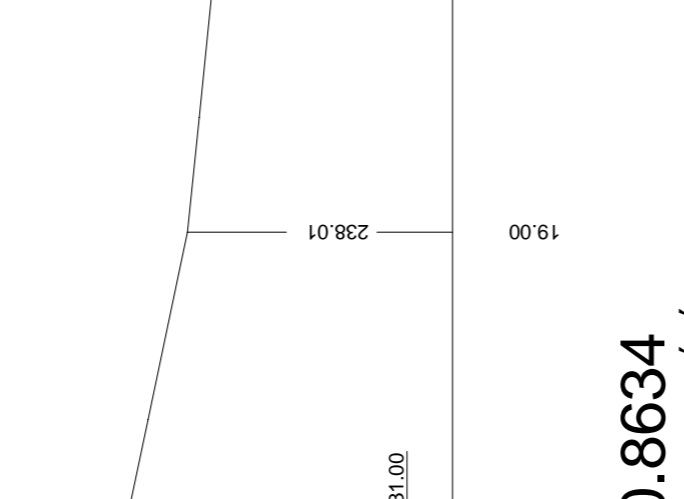

PF 13 KM 0.7062
M 500/200

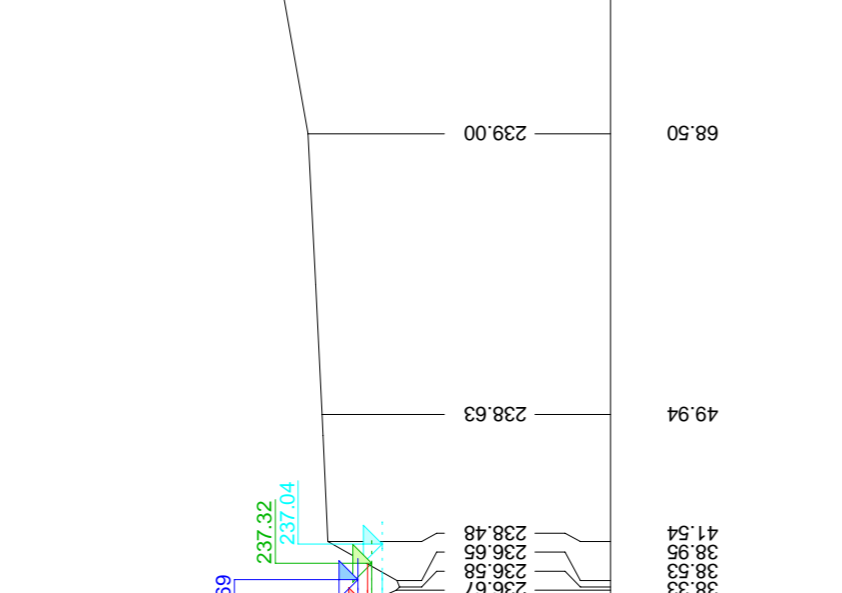
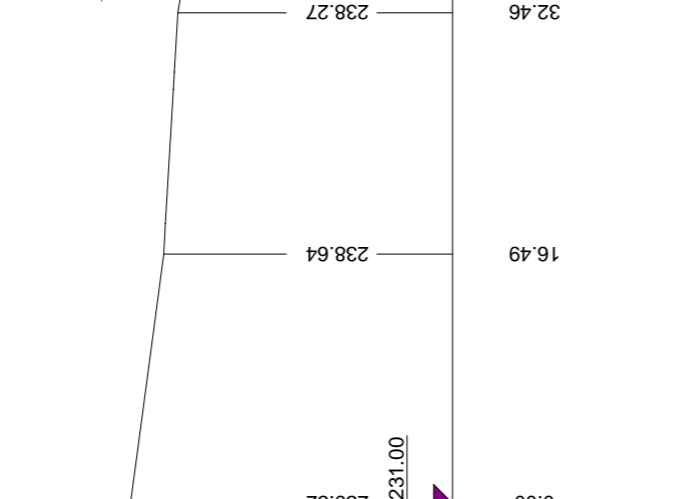

PF 14 KM 0.7781
PROPUSTEK KM 0.7731 DN 1000

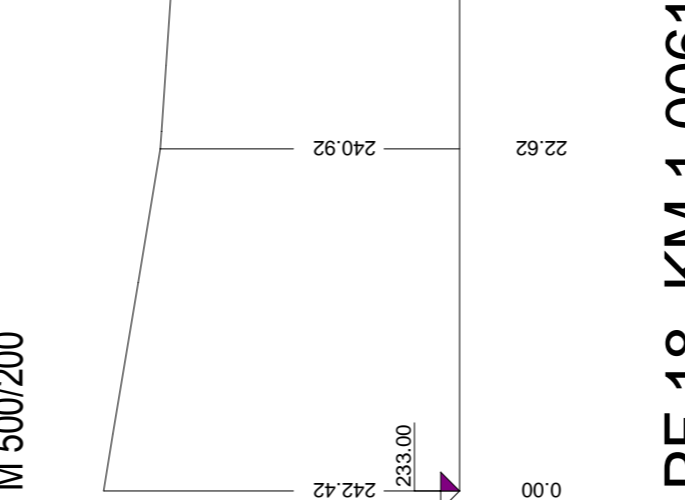

PF 15 KM 0.7841
M 500/200

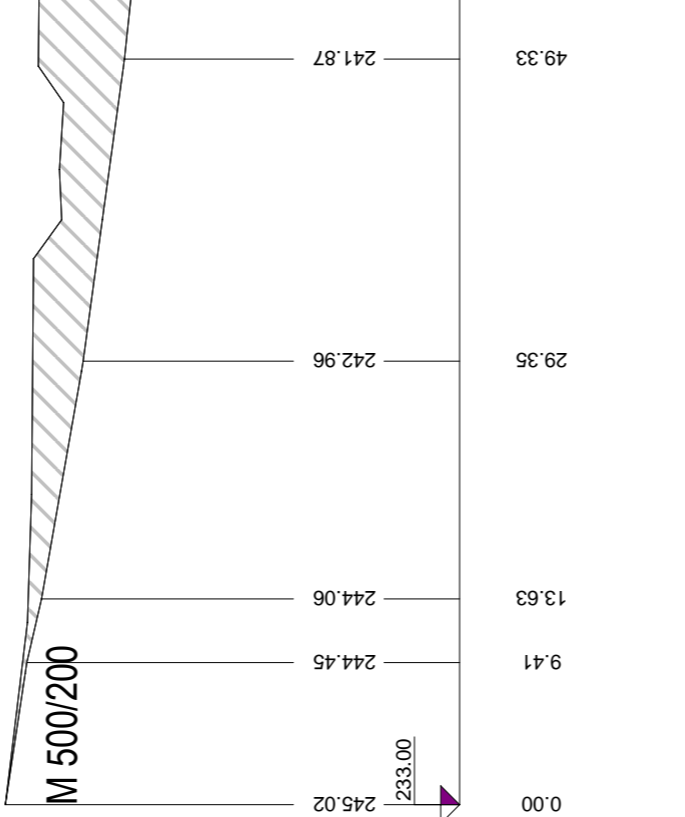

PF 16 KM 0.8332
VYUŠTENÍ Z PROPUSTI HRAZI DN 1000 KM 0.8332

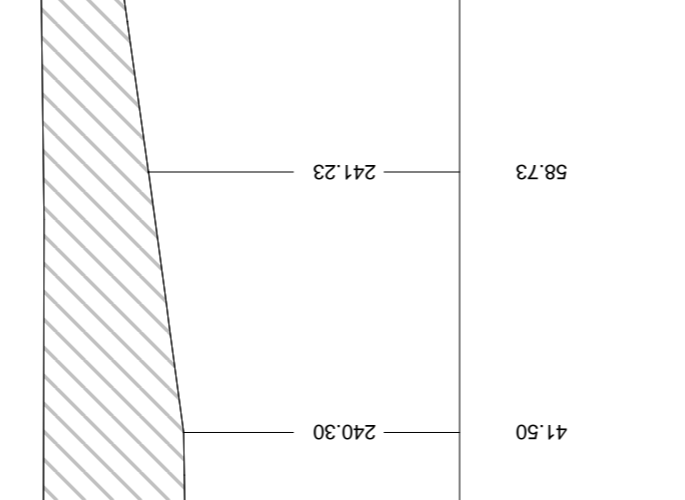

PF 17 KM 0.8634
ZAUSTENÍ DO PROPUSTI HRAZI DN 600 KM 0.8634

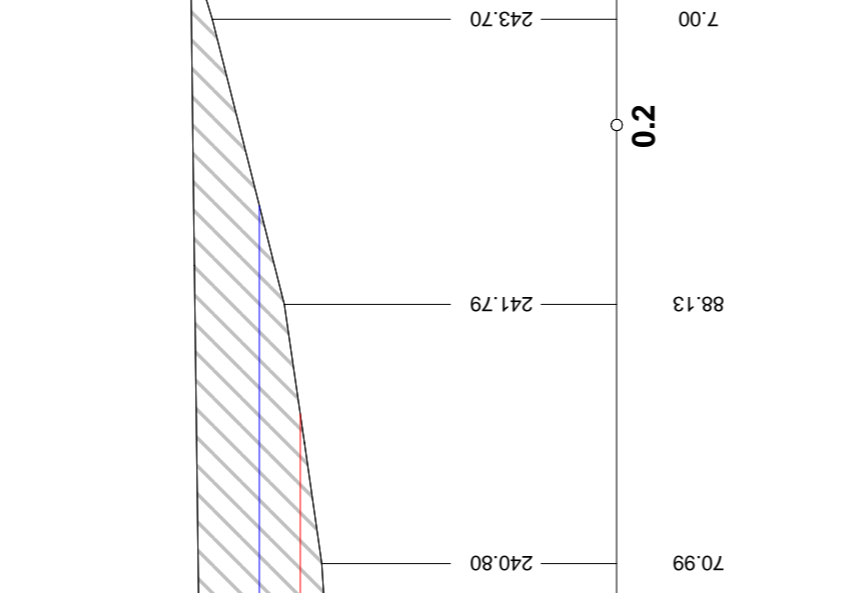
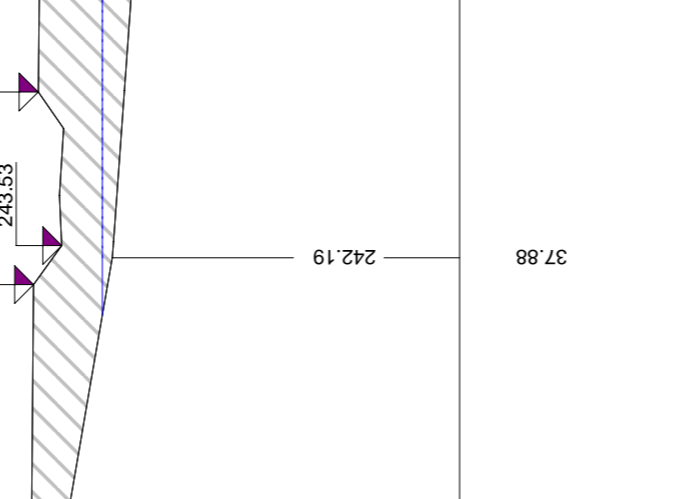

PF 18 KM 1.0061
M 500/200

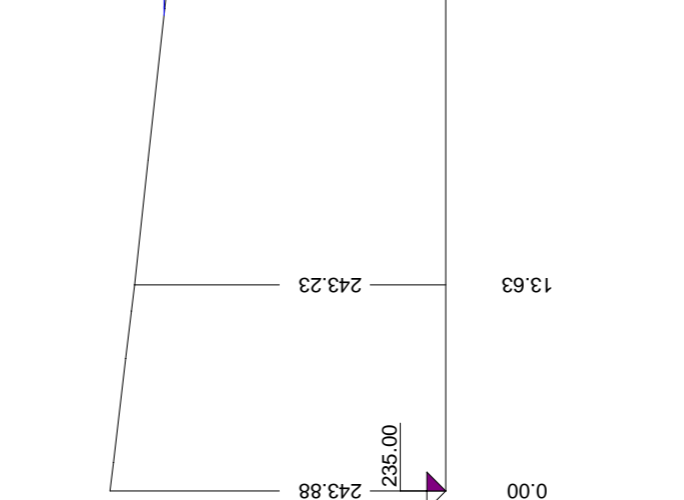

PF 19 KM 1.1609
M 500/200

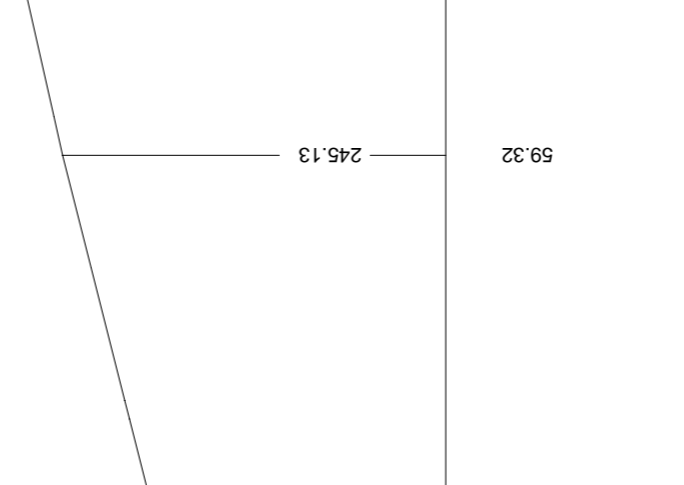

PF 20 KM 1.2266
M 500/200

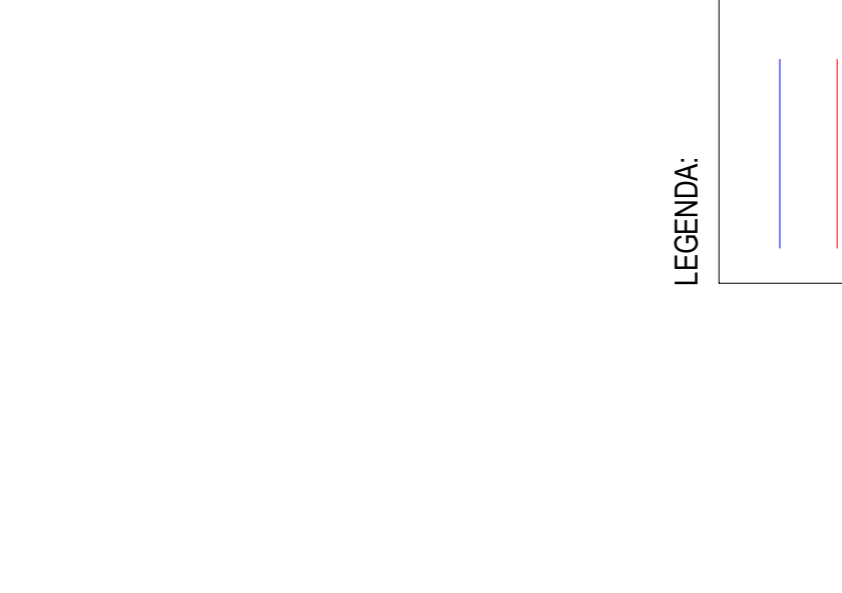
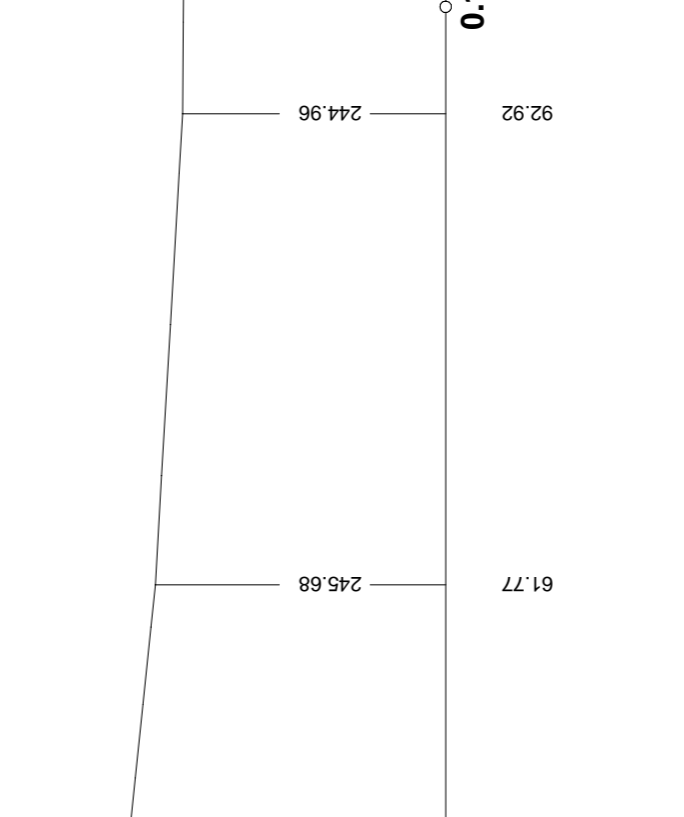

PF 21 KM 1.3159
M 500/200

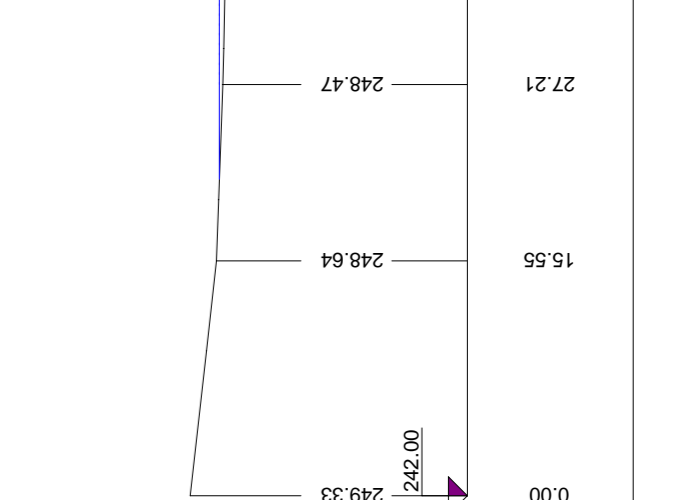

PF 22 KM 1.3982
M 500/200

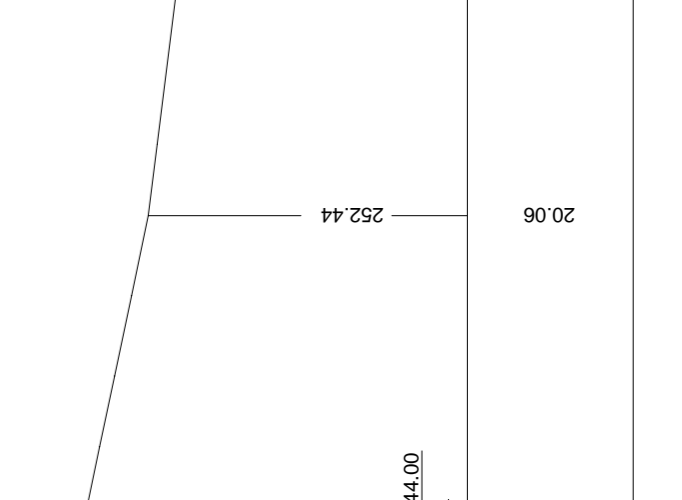

PF 23 KM 1.4538
SILNIČNÍ MOST (BENES) KM 1.4528

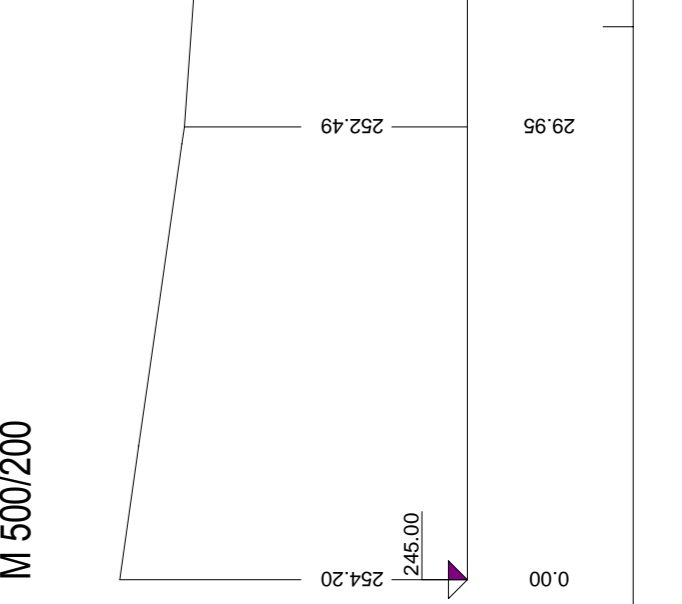

LEGENDA:

- 0100
- 0200
- 0300
- 01

POVOŘÍ MORAVY
Ing. J. Remek
Ing. Simčková
Ing. L. Jeliškova
Bc. A. Dvořáková 11
220283
Povodí Moravy s.p.

WVodov (km)
1:500/200
1:500/200

STUŽIE
S-2022001
Číslo kópie

ZAPLAVOVÉ ÚZEMÍ PODOLSKÉHO POTOKA
KM 0.000 - 1.454

PRŮMĚRNÉ PROFILY PODOLSKÉHO POTOKA PF 1 - 23
Měřítko 1:500/200
C. 1.1