

PF 1 KM -0.0095

PF NA RÍČCE PO ZAUSTUENÍ PRACKÉHO POTOKA

60/24

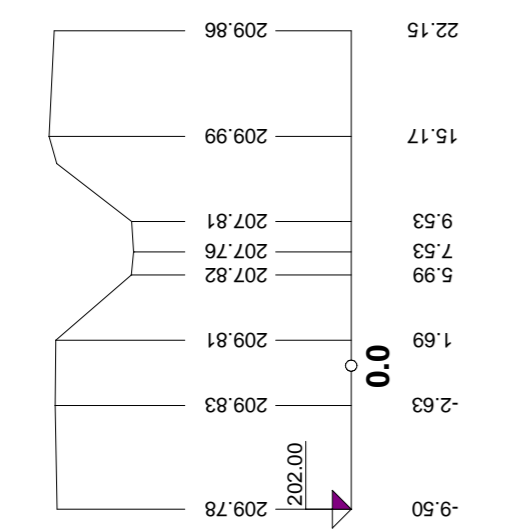

PF 2 KM 0.0154

PRACKÝ POTOK

60/24

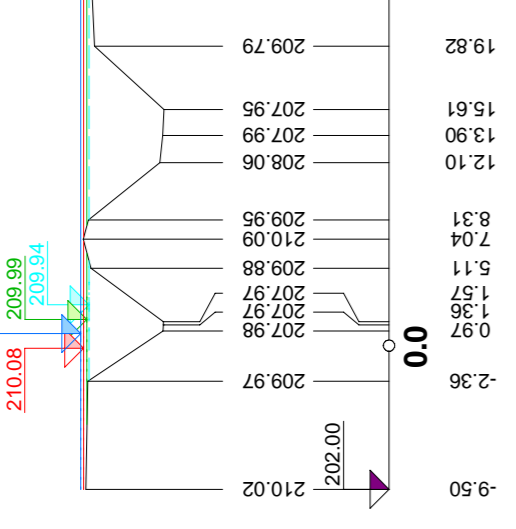

PF 3 KM 0.0346

DŘEVĚNÁ LÁVKA KM 0.0342

60/24

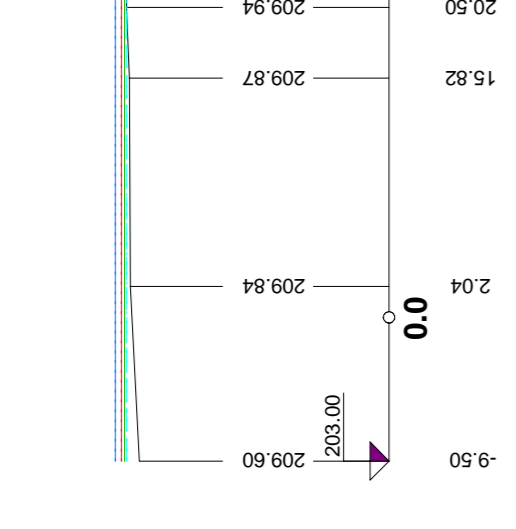

PF 4 KM 0.0964



PF 5 KM 0.1421



PF 6 KM 0.1573

VYÚSTĚNÍ ZE ZATRUBNĚNÍ KM 0.1573 DN 1200

M 200/200

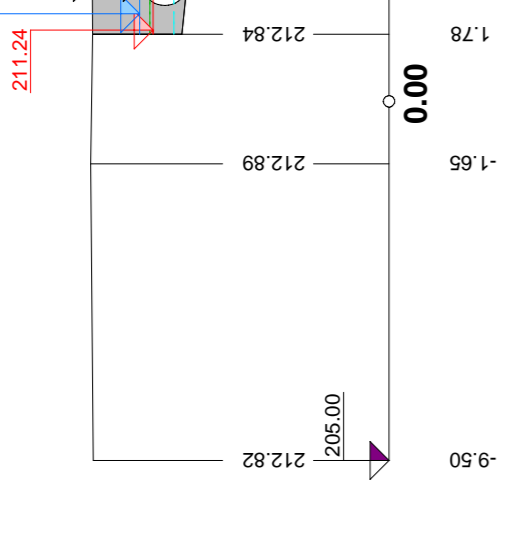

PF 7 KM 0.1708

ZAUSTUENÍ DO ZATRUBNĚNÍ KM 0.1708 DN 1200

M 200/200

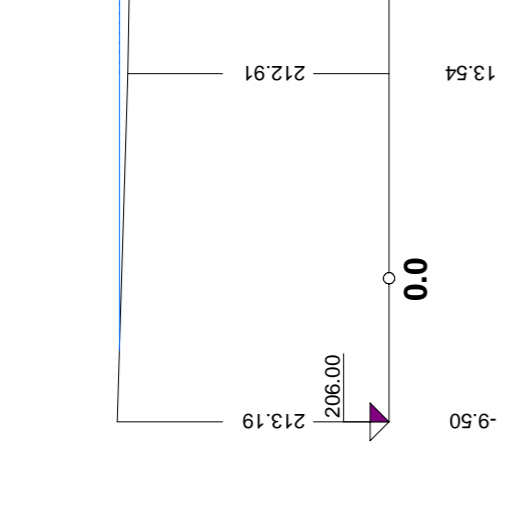

PF 8 KM 0.1821



PF 9 KM 0.2469



PF 11 KM 0.3468

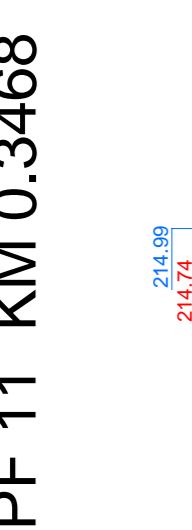

PF 10 KM 0.3215

SILNIČNÍ MOST KM 0.3165

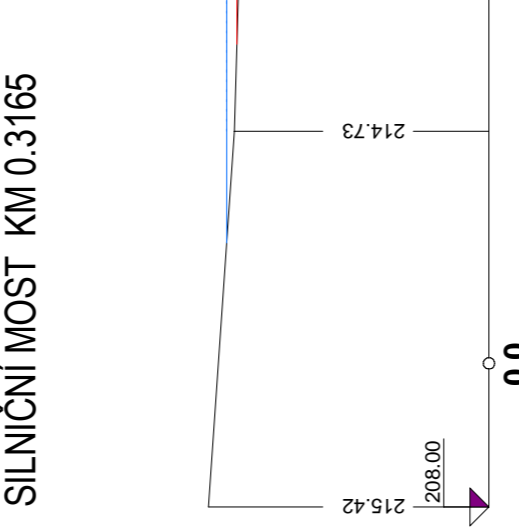

PF 12 KM 0.4319

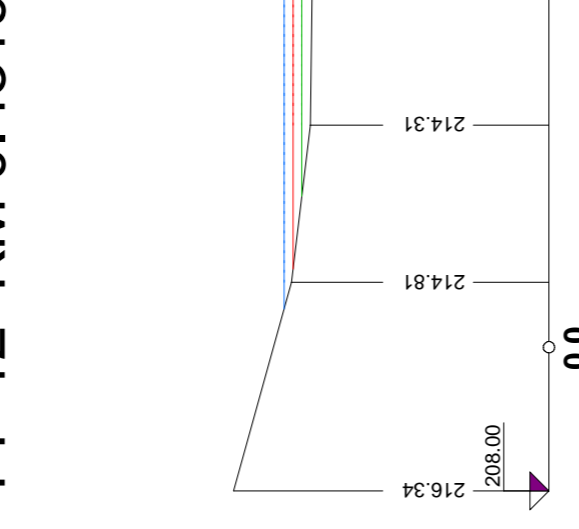

PF 13 KM 0.5602

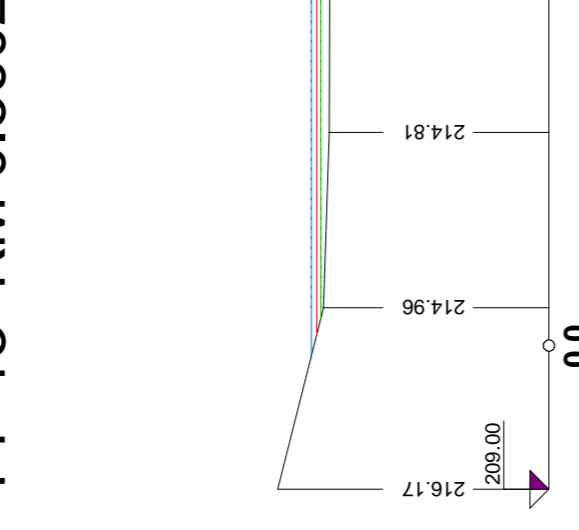

PF 14 KM 0.7321

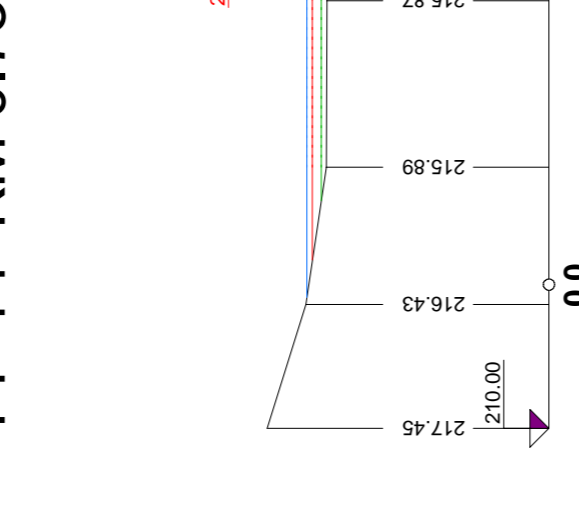

PF 15 KM 0.8607

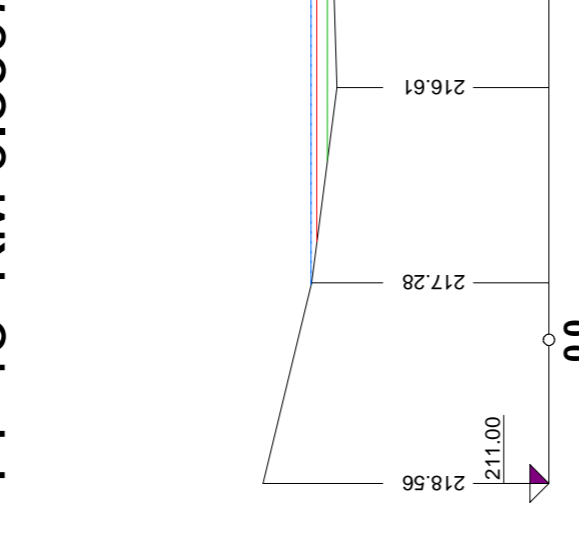

PF 16 KM 1.0280

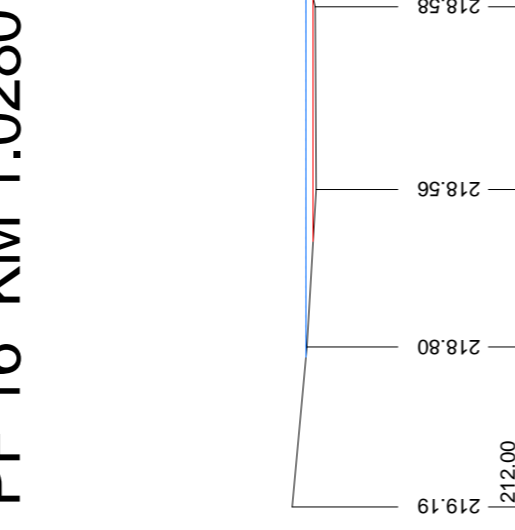

PF 17 KM 1.1757

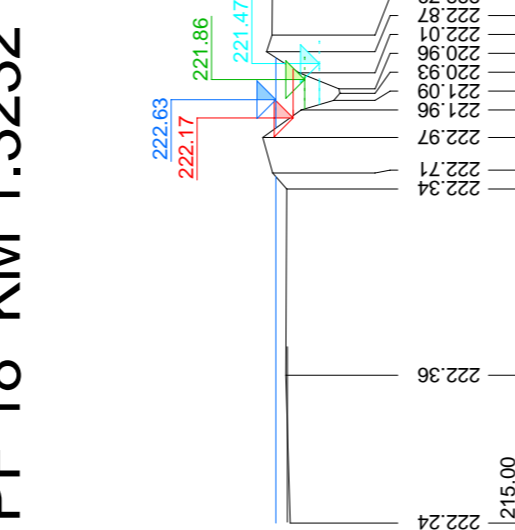

PF 18 KM 1.3232

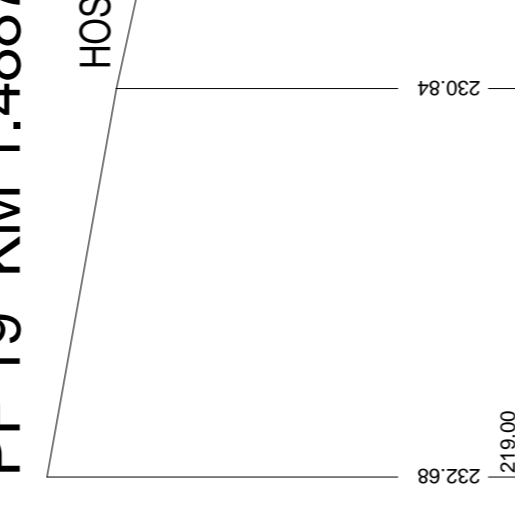

PF 19 KM 1.4887

HOSPODÁŘSKÝ MOSTEK, PROPUSTEK KM 1.4923 DN 1200

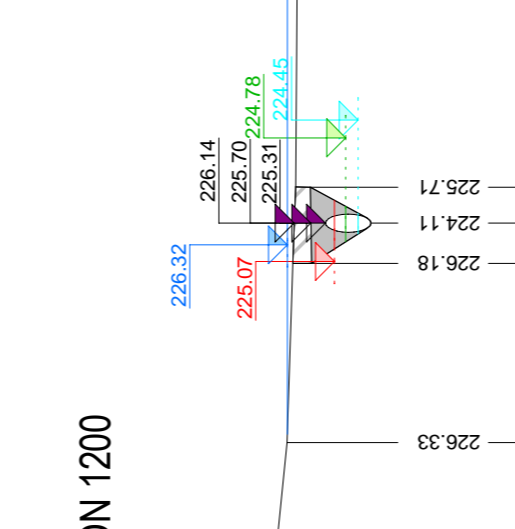

PF 20 KM 1.6549

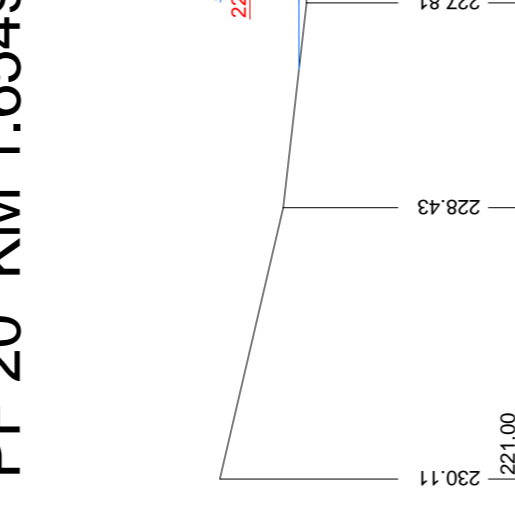

PF 21 KM 1.7797

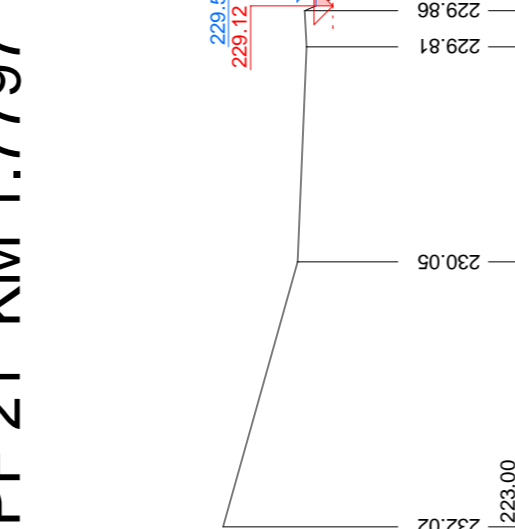

PF 22 KM 1.9301

HOSPODÁŘSKÝ MOSTEK, PROPUSTEK KM 1.9269 DN 1200

VEDENÍ NADZEMNÍ D 110

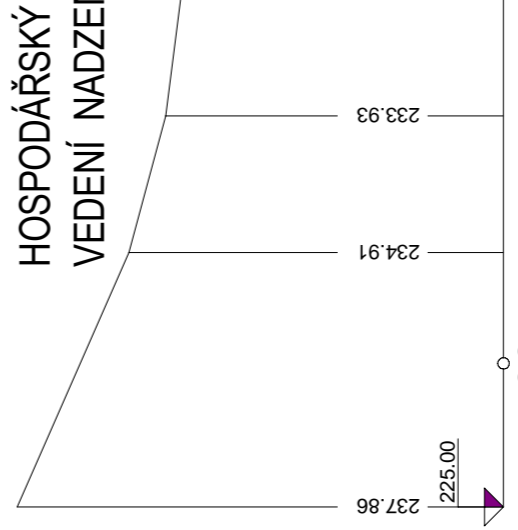

PF 23 KM 1.9418

DŘEVĚNÁ LÁVKA KM 1.9414

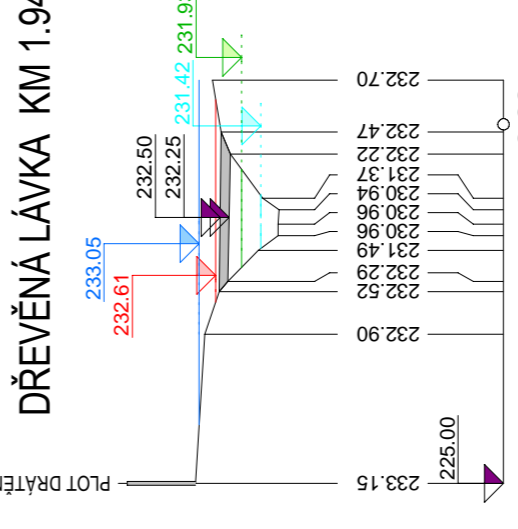

PF 24 KM 1.9631

DŘEVĚNÁ LÁVKA KM 1.9627

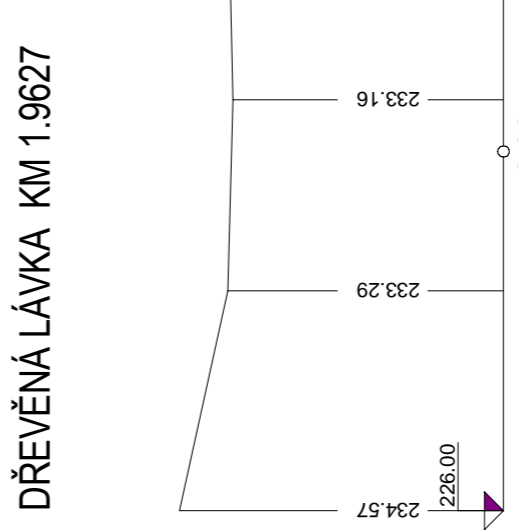

PF 25 KM 2.0017

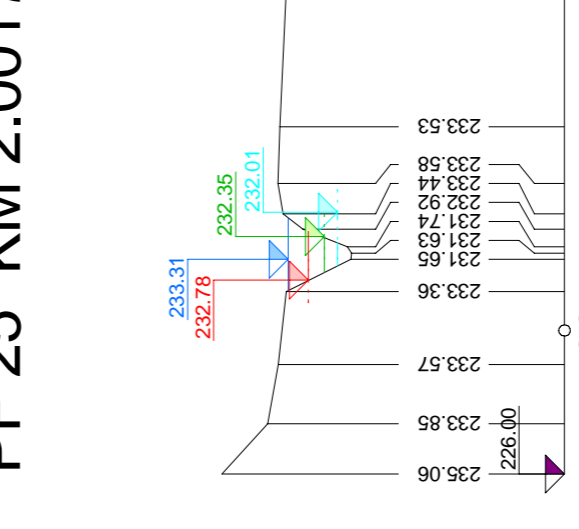

PF 26 KM 2.0584

DŘEVĚNÁ LÁVKA KM 2.0580

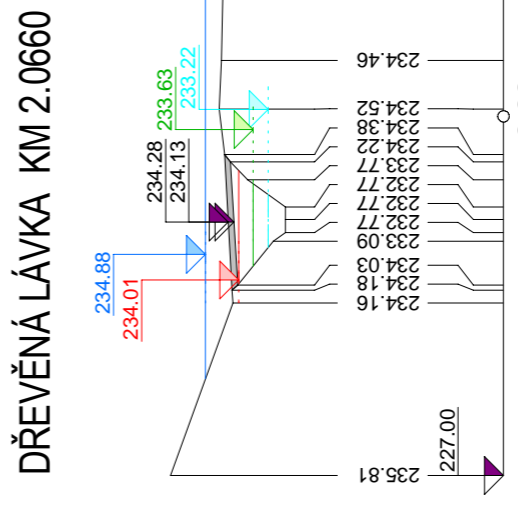

PF 27 KM 2.0664

DŘEVĚNÁ LÁVKA KM 2.0660

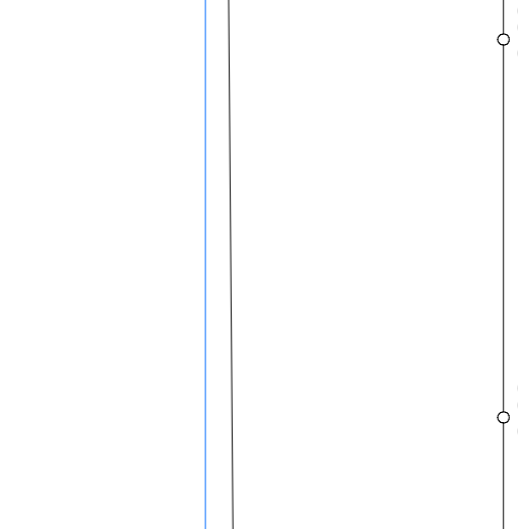

PF 28 KM 2.1078

DŘEVĚNÁ LÁVKA KM 2.1076

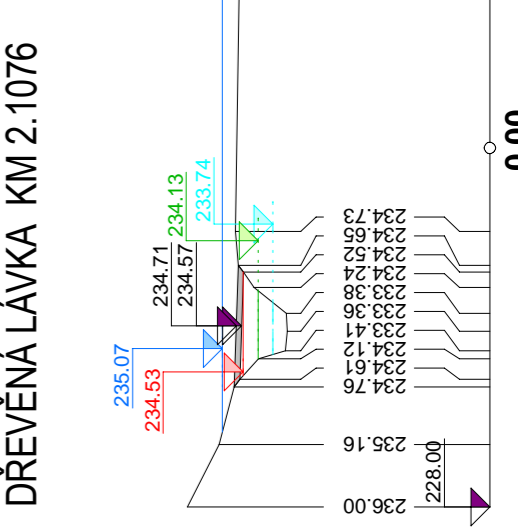

PF 29 KM 2.2059

DŘEVĚNÁ LÁVKA KM 2.2055

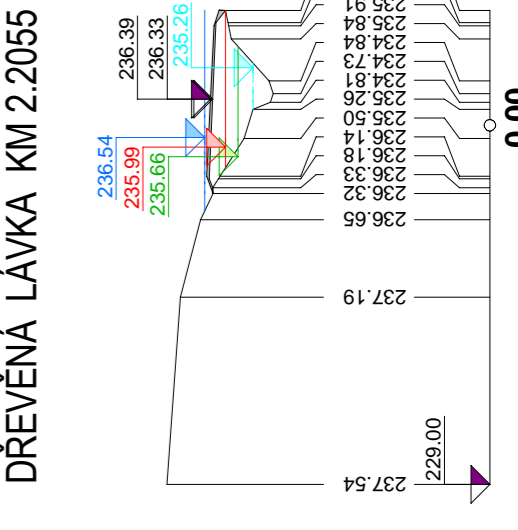

PF 30 KM 2.2514

DŘEVĚNÁ LÁVKA KM 2.2507

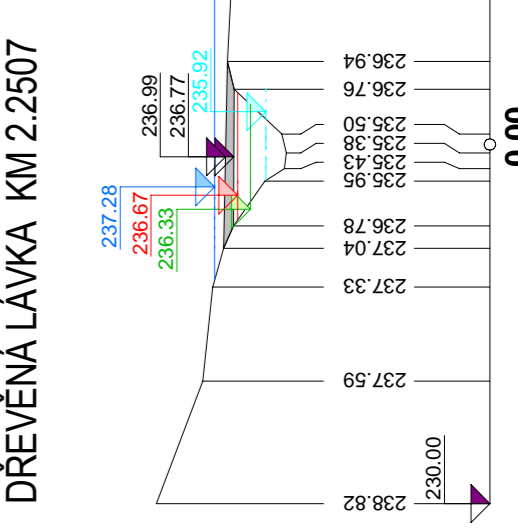

PF 31 KM 2.2751

BETONOVÁ LÁVKA KM 2.2743

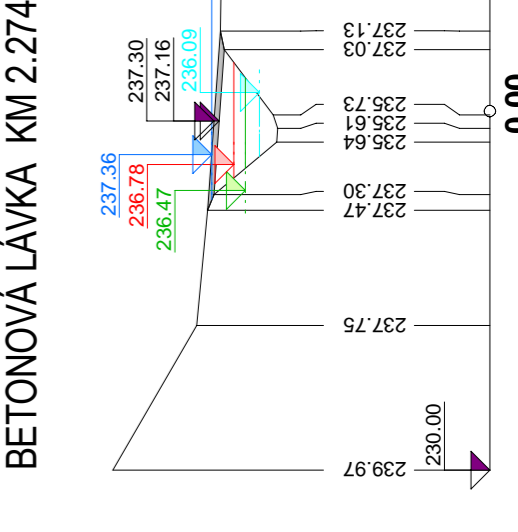

PF 32 KM 2.2879

DŘEVĚNÁ LÁVKA KM 2.2877

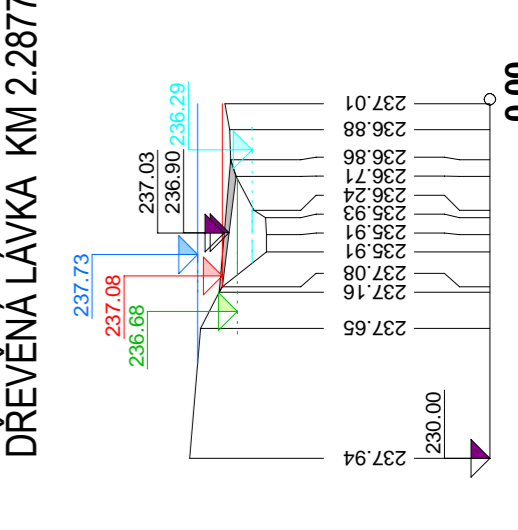

LEGENDA:

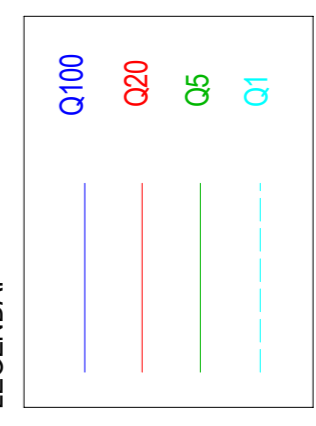

Zodp. projektant	Výpracoval	Kreslil	Nadobudl	POVOŘÍ MORAVY
Ing. J. Řečník	Ing. Šimekova	Ing. Šimekova	Ing. J. Lejtnová	Ing. Lejtnová s.p.
Kol. J. Blahosrský	Čištění	Čištění	Čištění	Čištění
Objednatel	Investor	Projektant	Datum	11/2020
Povodí Moravy, s.p.	Povodí Moravy, s.p.	Povodí Moravy, s.p.	Účel	STUDIE
			Číslo zakázky	S-2020/003
			Číslo kopie	
			Velikost	1:500/200
			Škála	C.1.1